

SECTION A-A

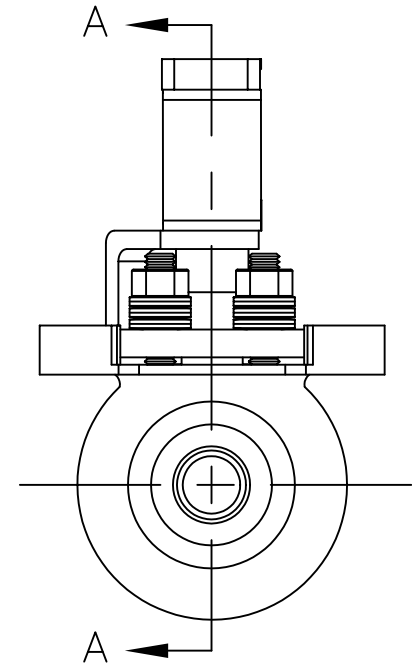
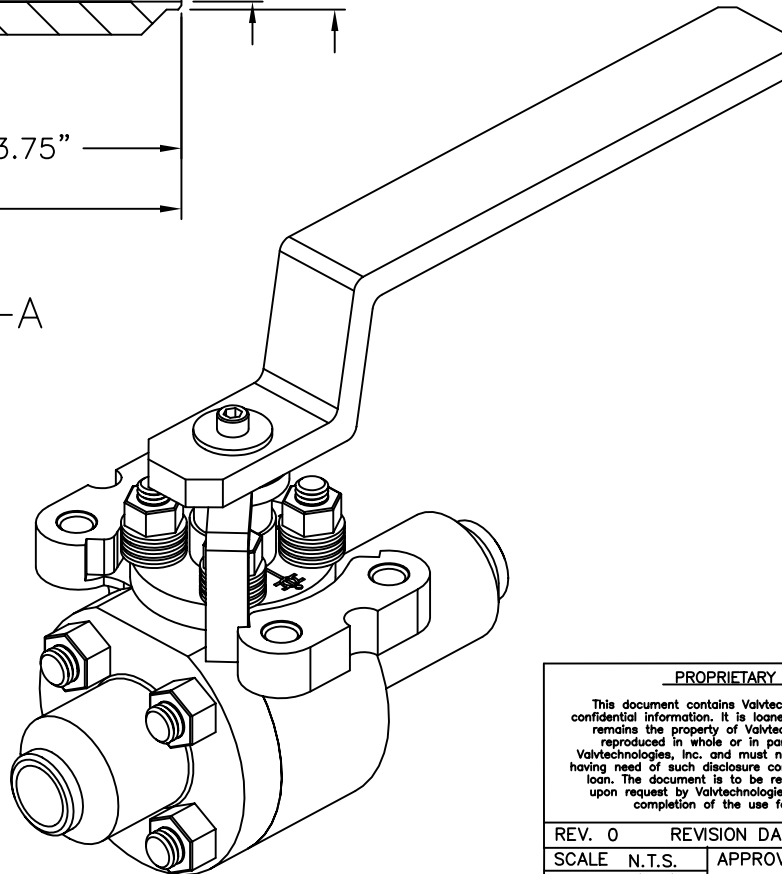

<u>PROPRIETARY INFORMATION</u>				VALVTECHNOLOGIES		HOUSTON TEXAS	
This document contains Valvtechnologies, Inc. proprietary and confidential information. It is loaned for limited purposes only and remains the property of Valvtechnologies, Inc. It may not be reproduced in whole or in part without written consent of Valvtechnologies, Inc. and must not be disclosed to persons not having need of such disclosure consistent with the purpose of the loan. The document is to be returned to Valvtechnologies, Inc. upon request by Valvtechnologies, Inc. and in all events upon completion of the use for which it was loaned.				1/2" V1-3-BW-STD, w/LEVER ANSI 150, 300 & 600#			
REV. 0	REVISION DATE:			MATERIAL	DRAWING NUMBER: V1-3-BW-STD-1/2		
SCALE N.T.S.	APPROVED BY	DRAWN BY ZB					
DATE 07/18/03		CHECKED					